

## General Description

The AAT4280 SmartSwitch is a P-channel MOSFET power switch designed for high-side load switching applications. The P-channel MOSFET device has a typical  $R_{DS(ON)}$  of 80m $\Omega$ , allowing increased load switch power handling capacity. This device is available in three different versions with flexible turn on and off characteristics from very fast to slew rate limited. The standard AAT4280 (-1) version has a slew rate limited turn on load switch and is functionally compatible with the AAT4250 device while offering superior  $R_{DS(ON)}$  characteristics. The AAT4280 (-2) version features fast load switch turn on capabilities, typically less than 500ns turn on and 3 $\mu$ s turn off times. The AAT4280 (-3) variation offers a shutdown load discharge circuit to rapidly turn off a load circuit when the switch is disabled. All AAT4280 load switch versions operate with an input voltage ranging from 1.8V to 5.5V, making them ideal for both 3V and 5V systems. The AAT4280 also features an under-voltage lockout which turns the switch off when an input under-voltage condition exists. Input logic levels are TTL and 2.5V to 5V CMOS compatible. The quiescent supply current is very low, typically 2.5 $\mu$ A. In shutdown mode, the supply current decreases to less than 1 $\mu$ A.

The AAT4280 is available in a Pb-free, 6-pin SOT23 or 8-pin SC70JW package and is specified over the -40°C to +85°C temperature range.

## Features

- 1.8V to 5.5V Input Voltage Range
- Very Low  $R_{DS(ON)}$ , Typically 80m $\Omega$  (5V)
- Slew Rate Limited Turn-On Time Options
  - 1ms
  - 0.5 $\mu$ s
  - 100 $\mu$ s
- Fast Shutdown Load Discharge Option
- Low Quiescent Current
  - 2.5 $\mu$ A Typical
  - 1 $\mu$ A Max in Shutdown
- TTL/CMOS Input Logic Level
- Temperature Range: -40°C to +85°C
- 4kV ESD Rating
- 6-Pin SOT23 or 8-Pin SC70JW Package

## Applications

- Cellular Telephones
- Digital Still Cameras
- Hot Swap Supplies
- Notebook Computers
- Personal Communication Devices
- Personal Digital Assistants (PDA)

## Typical Application

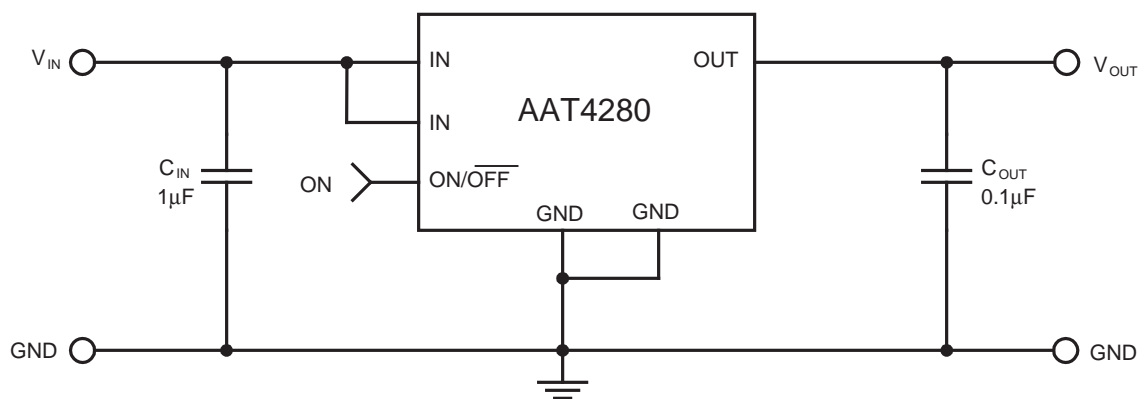

## Pin Descriptions

Pin Number		Symbol	Function
SOT23-6	SC70JW-8		
1	2	OUT	This pin is the P-channel MOSFET drain connection. Bypass to ground through a 0.1µF capacitor.
2, 5	4	GND	Ground connection.
3	3	ON/OFF	Enable input.
4, 6	1, 5, 6, 7, 8	IN	This pin is the input to the P-channel MOSFET source. Bypass to ground through a 1.0µF capacitor.

## Pin Configuration

**SOT23-6**  
(Top View)

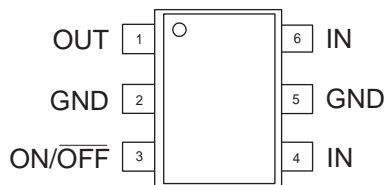

**SC70JW-8**  
(Top View)

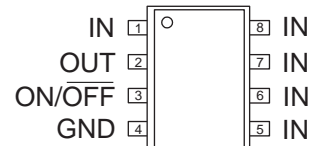

## Selector Guide

Part Number	Slew Rate (typ)	Active Pull Down	Enable
AAT4280-1	1ms		Active High
AAT4280-2	0.5 $\mu$ s		Active High
AAT4280-3	100 $\mu$ s	✓	Active High

## Absolute Maximum Ratings<sup>1</sup>

T<sub>A</sub> = 25°C, unless otherwise noted.

Symbol	Description	Value	Units	
V <sub>IN</sub>	IN to GND	-0.3 to 6	V	
V <sub>ON</sub>	ON/OFF to GND	-0.3 to 6	V	
V <sub>OUT</sub>	OUT to GND	-0.3 to V <sub>IN</sub> + 0.3	V	
I <sub>MAX</sub>	Maximum Continuous Switch Current	2.3	A	
I <sub>DM</sub>	Maximum Pulsed Current	IN $\geq$ 2.5V	6	A
		IN < 2.5V	3	A
T <sub>J</sub>	Operating Junction Temperature Range	-40 to 150	°C	
T <sub>S</sub>	Storage Temperature Range	-65 to 150	°C	
T <sub>LEAD</sub>	Maximum Soldering Temperature (at leads)	300	°C	
V <sub>ESD</sub>	ESD Rating <sup>2</sup> - HBM	4000	V	

## Thermal Characteristics<sup>3</sup>

Symbol	Description	Value		Units
		SOT23-6	SC70JW-8	
$\Theta_{JA}$	Thermal Resistance	120	140	°C/W
P <sub>D</sub>	Power Dissipation	833	714	mW

1. -Stresses above those listed in Absolute Maximum Ratings may cause permanent damage to the device. Functional operation at conditions other than the operating conditions specified is not implied. Only one Absolute Maximum Rating should be applied at any one time.

2. Human body model is a 100pF capacitor discharged through a 1.5k $\Omega$  resistor into each pin.

3. Mounted on an AAT4280 demo board in still 25°C air.

## Electrical Characteristics

$V_{IN} = 5V$ ,  $T_A = -40^{\circ}C$  to  $+85^{\circ}C$ , unless otherwise noted. Typical values are  $T_A = 25^{\circ}C$ .

Symbol	Description	Conditions	Min	Typ	Max	Units
<b>AAT4280 All Versions</b>						
$V_{IN}$	Operation Voltage		1.81		5.5	V
$V_{UVLO}$	Under-Voltage Lockout	$V_{IN}$ Falling	1.0	1.4	1.8	V
$V_{UVLO(hys)}$	Under-Voltage Lockout Hysteresis			250		mV
$I_Q$	Quiescent Current	ON/ $\overline{OFF}$ = Active		2.5	4	$\mu A$
$I_{Q(OFF)}$	Off Supply Current	ON/ $\overline{OFF}$ = Inactive, OUT = Open			1	$\mu A$
$I_{SD(OFF)}$	Off Switch Current	ON/ $\overline{OFF}$ = Inactive, $V_{OUT} = 0$			1	$\mu A$
$R_{DS(ON)}$	On Resistance	$V_{IN} = 5V$ , $T_A = 25^{\circ}C$		80	120	m $\Omega$
		$V_{IN} = 4.2V$ , $T_A = 25^{\circ}C$		85	130	
		$V_{IN} = 3V$ , $T_A = 25^{\circ}C$		100	150	
		$V_{IN} = 1.8V$ , $T_A = 25^{\circ}C$		160	250	
$TC_{RDS}$	On Resistance Temperature Coefficient			2800		ppm/ $^{\circ}C$
$V_{IL}$	ON/ $\overline{OFF}$ Input Logic Low Voltage	$V_{IN} = 2.7V$ to $5.5V^2$			0.8	V
		$V_{IN} = 2.7V$ to $\leq 4.2V$	2			
$V_{IH}$	ON/ $\overline{OFF}$ Input Logic High Voltage	$V_{IN} = 3.3V$	1.8			V
		$V_{IN} = >4.2V$ to $5.5V$	2.4			
$I_{SINK}$	ON/ $\overline{OFF}$ Input Leakage	$V_{ON/OFF} = 5.5V$			1	$\mu A$
<b>AAT4280-1</b>						
$T_{D(ON)}$	Output Turn-On Delay	$V_{IN} = 5V$ , $R_{LOAD} = 10\Omega$ , $T_A = 25^{\circ}C$		20	40	$\mu s$
$T_{ON}$	Output Turn-On Rise Time	$V_{IN} = 5V$ , $R_{LOAD} = 10\Omega$ , $T_A = 25^{\circ}C$		1000	1500	$\mu s$
$T_{D(OFF)}$	Output Turn-Off Delay Time	$V_{IN} = 5V$ , $R_{LOAD} = 10\Omega$ , $T_A = 25^{\circ}C$		4	10	$\mu s$
<b>AAT4280-2</b>						
$T_{D(ON)}$	Output Turn-On Delay	$V_{IN} = 5V$ , $R_{LOAD} = 10\Omega$ , $T_A = 25^{\circ}C$		0.5	2	$\mu s$
$T_{ON}$	Output Turn-On Rise Time	$V_{IN} = 5V$ , $R_{LOAD} = 10\Omega$ , $T_A = 25^{\circ}C$		0.5	1	$\mu s$
$T_{D(OFF)}$	Output Turn-Off Delay Time	$V_{IN} = 5V$ , $R_{LOAD} = 10\Omega$ , $T_A = 25^{\circ}C$		4	10	$\mu s$
<b>AAT4280-3</b>						
$T_{D(ON)}$	Output Turn-On Delay	$V_{IN} = 5V$ , $R_{LOAD} = 10\Omega$ , $T_A = 25^{\circ}C$		20	40	$\mu s$
$T_{ON}$	Output Turn-On Rise Time	$V_{IN} = 5V$ , $R_{LOAD} = 10\Omega$ , $T_A = 25^{\circ}C$		100	150	$\mu s$
$T_{D(OFF)}$	Output Turn-Off Delay Time	$V_{IN} = 5V$ , $R_{LOAD} = 10\Omega$ , $T_A = 25^{\circ}C$		4	10	$\mu s$
$R_{PD}$	Output Pull-Down Resistance During $\overline{OFF}$	ON/ $\overline{OFF}$ = Inactive, $T_A = 25^{\circ}C$		150	250	$\Omega$

1. Part requires minimum start-up of  $V_{IN} \square 2.0V$  to ensure operation down to 1.8V.

2. For  $V_{IN}$  outside this range, consult typical ON/ $\overline{OFF}$  threshold curve.

## Typical Characteristics

Unless otherwise noted,  $V_{IN} = 5V$ ,  $T_A = 25^\circ C$ .

Quiescent Current vs. Temperature

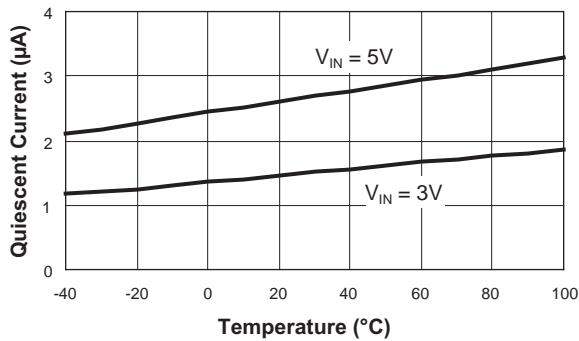

Quiescent Current vs. Input Voltage

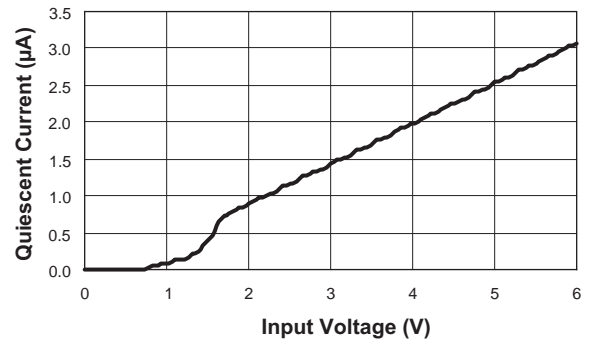

$R_{DS(ON)}$  vs. Input Voltage

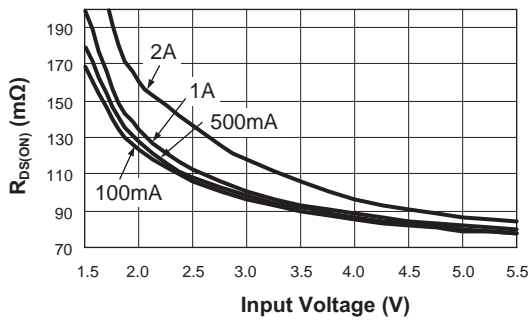

$R_{DS(ON)}$  vs. Temperature

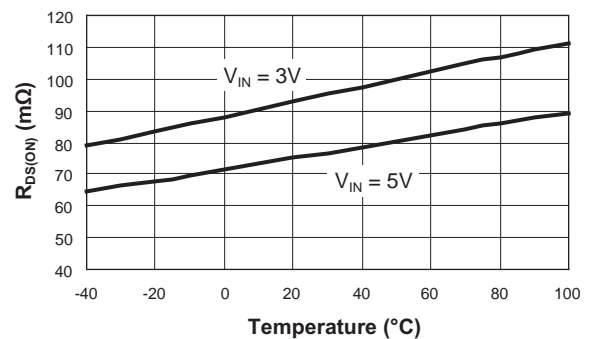

ON/OFF Threshold vs. Input Voltage

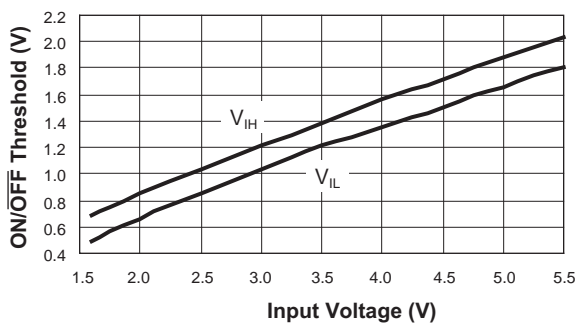

Off-Switch Current vs. Temperature

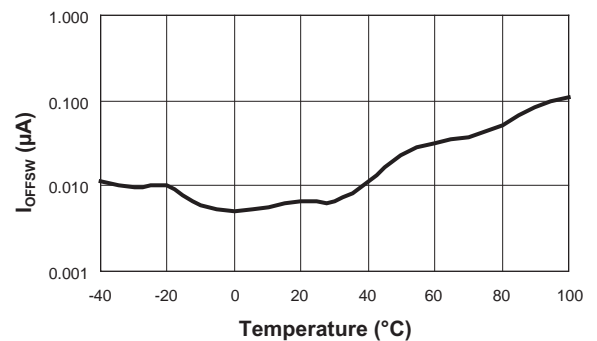

**Typical Characteristics—AAT4280-1**

Unless otherwise noted,  $V_{IN} = 5V$ ,  $T_A = 25^\circ C$ .

**AAT4280-1 Turn-On**  
( $V_{IN} = 3V$ ;  $R_L = 6\Omega$ )

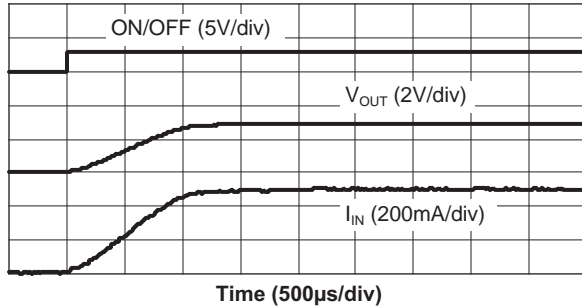

**AAT4280-1 Turn-On**  
( $V_{IN} = 5V$ ;  $R_L = 10\Omega$ )

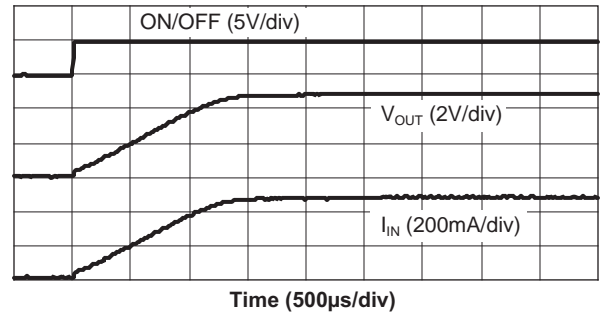

**AAT4280-1 Turn-Off**  
( $V_{IN} = 3V$ ;  $R_L = 6\Omega$ )

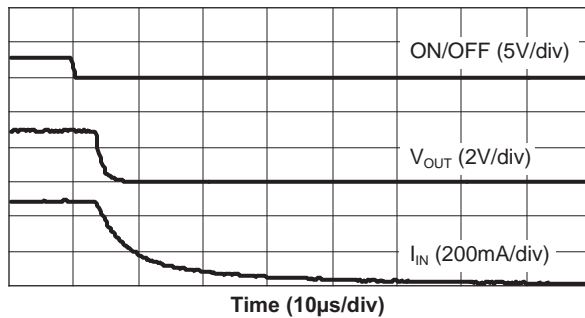

**AAT4280-1 Turn-Off**  
( $V_{IN} = 5V$ ;  $R_L = 10\Omega$ )

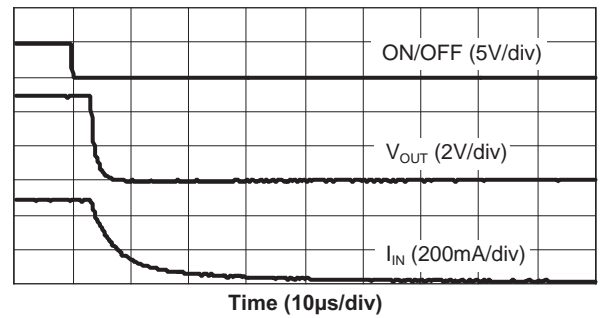

**Typical Characteristics—AAT4280-2**

Unless otherwise noted,  $V_{IN} = 5V$ ,  $T_A = 25^\circ C$ .

**AAT4280-2 Turn-On**  
( $V_{IN} = 3V$ ;  $R_L = 6\Omega$ )

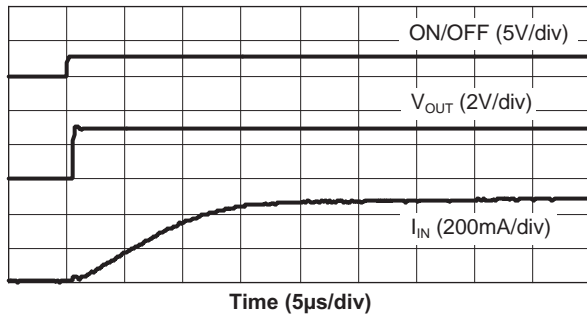

**AAT4280-2 Turn-On**  
( $V_{IN} = 5V$ ;  $R_L = 10\Omega$ )

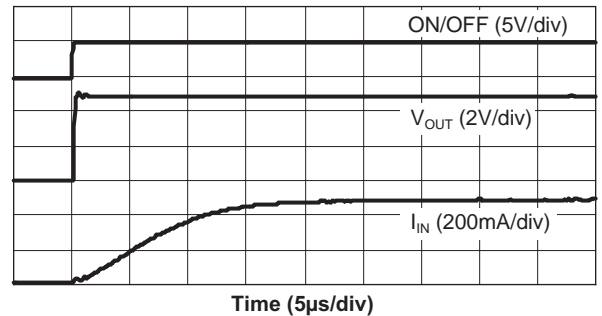

**AAT4280-2 Turn-Off**  
( $V_{IN} = 3V$ ;  $R_L = 6\Omega$ )

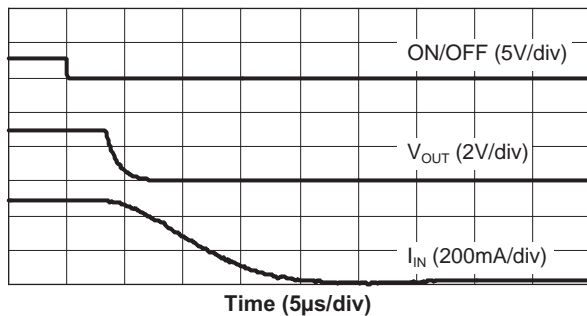

**AAT4280-2 Turn-Off**  
( $V_{IN} = 5V$ ;  $R_L = 10\Omega$ )

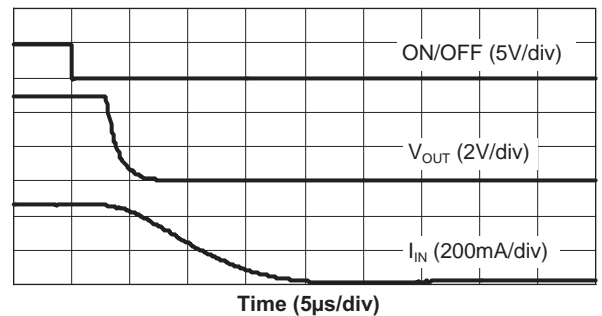

**Typical Characteristics—AAT4280-3**

Unless otherwise noted,  $V_{IN} = 5V$ ,  $T_A = 25^\circ C$ .

**AAT4280-3 Turn-On**  
( $V_{IN} = 3V$ ;  $R_L = 6\Omega$ )

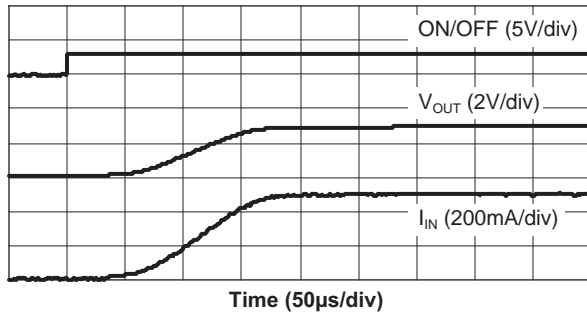

**AAT4280-3 Turn-On**  
( $V_{IN} = 5V$ ;  $R_L = 10\Omega$ )

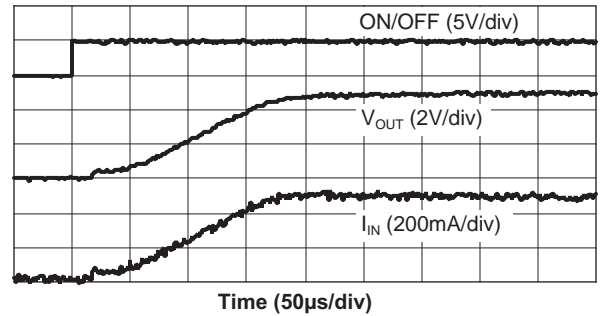

**AAT4280-3 Turn-Off**  
( $V_{IN} = 3V$ ;  $R_L = 6\Omega$ )

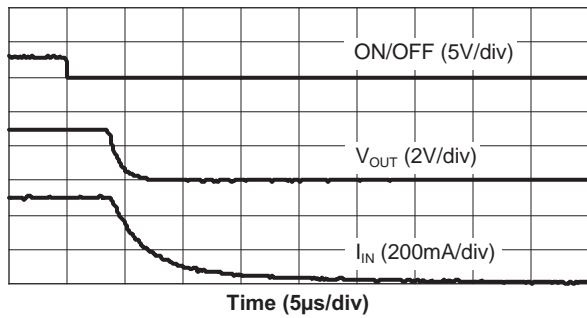

**AAT4280-3 Turn-Off**  
( $V_{IN} = 5V$ ;  $R_L = 10\Omega$ )

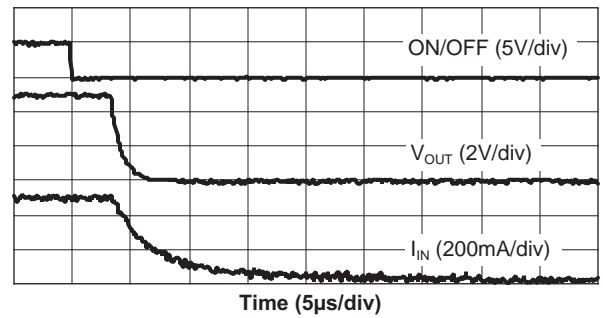



## Functional Block Diagram

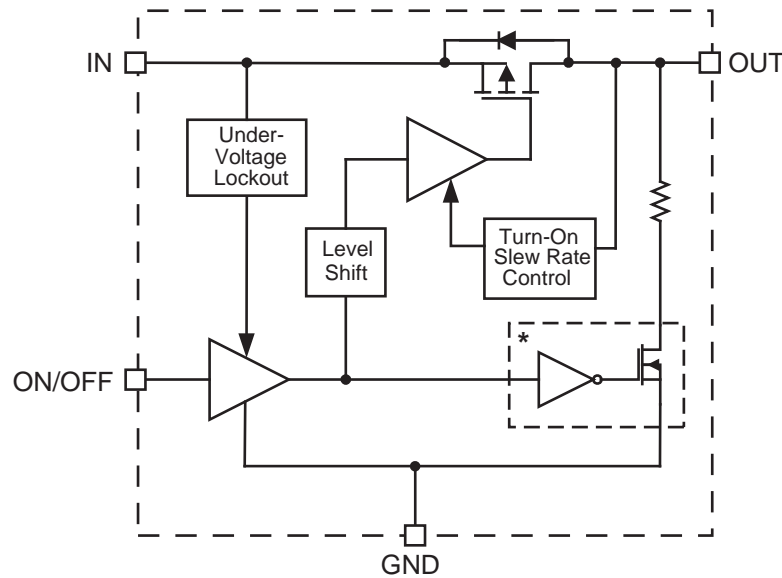

\*AAT4280-3 only

## Functional Description

The AAT4280 is a family of flexible P-channel MOSFET power switches designed for high-side load switching applications. There are three versions of the AAT4280 with different turn-on and turn-off characteristics to choose from, depending upon the specific requirements of an application. The first version, the AAT4280-1, has a moderate turn-on slew rate feature, which reduces inrush current when the MOSFET is turned on. This function allows the load switch to be implemented with either a small input capacitor or no input capacitor at all. During turn-on slewing, the current ramps linearly until it reaches the level required for the output load condition. The proprietary turn-on current control method works by careful control and monitoring of the MOSFET gate voltage. When the device is switched ON, the gate voltage is quickly increased to the threshold level of the MOSFET. Once at this level, the current begins to slew as the gate voltage is slowly increased until the MOSFET becomes fully enhanced. Once it has reached this point, the gate is quickly increased to the full input voltage and  $R_{DS(ON)}$  is minimized.

The second version, the AAT4280-2, is a very fast switch intended for high-speed switching applications. This version has no turn-on slew rate control and no special output discharge features.

The final version, the AAT4280-3, has the addition of a minimized slew rate limited turn-on function and a shut-down output discharge circuit to rapidly turn off a load when the load switch is disabled through the ON/OFF pin.

All versions of the AAT4280 operate with input voltages ranging from 1.8V to 5.5V. All versions of this device have extremely low operating current, making them ideal for battery-powered applications. In cases where the input voltage drops below 1.8V, the AAT4280 MOSFET device is protected from entering into the saturation region of operation by automatically shutting down through an under-voltage lockout control circuit. The ON/OFF control pin is TTL compatible and will also function with 2.5V to 5V logic systems, making the AAT4280 an ideal level-shifting load switch.

## Applications Information

### Input Capacitor

A 1µF or larger capacitor is typically recommended for  $C_{IN}$  in most applications. A  $C_{IN}$  capacitor is not required for basic operation. However,  $C_{IN}$  is useful in preventing load transients from affecting upstream circuits.  $C_{IN}$  should be located as close to the device  $V_{IN}$  pin as practically possible. Ceramic, tantalum, or aluminum electrolytic capacitors may be selected for  $C_{IN}$ . There is no specific capacitor ESR requirement for  $C_{IN}$ . However, for higher current operation, ceramic capacitors are recommended for  $C_{IN}$  due to their inherent capability over tantalum capacitors to withstand input current surges from low impedance sources, such as batteries in portable devices.

### Output Capacitor

For proper slew operation, a 0.1µF capacitor or greater between  $V_{OUT}$  and GND is recommended. The output capacitor has no specific capacitor type or ESR requirement. If desired,  $C_{OUT}$  may be increased without limit to accommodate any load transient condition without adversely affecting the device turn-on slew rate time.

### Enable Function

The AAT4280 features an enable / disable function. This pin (ON/OFF) is compatible with both TTL or CMOS logic.

### Reverse Output-to-Input Voltage Conditions and Protection

Under normal operating conditions, a parasitic diode exists between the output and input of the load switch. The input voltage should always remain greater than the output load voltage, maintaining a reverse bias on the internal parasitic diode. Conditions where  $V_{OUT}$  might exceed  $V_{IN}$  should be avoided since this would forward bias the internal parasitic diode and allow excessive current flow into the  $V_{OUT}$  pin and possibly damage the load switch.

In applications where there is a possibility of  $V_{OUT}$  exceeding  $V_{IN}$  for brief periods of time during normal operation, the use of a larger value  $C_{IN}$  capacitor is highly recommended. A larger value of  $C_{IN}$  with respect to  $C_{OUT}$  will effect a slower  $C_{IN}$  decay rate during shutdown, thus preventing  $V_{OUT}$  from exceeding  $V_{IN}$ . In applications where there is a greater danger of  $V_{OUT}$  exceeding

$V_{IN}$  for extended periods of time, it is recommended to place a Schottky diode from  $V_{IN}$  to  $V_{OUT}$  (connecting the cathode to  $V_{IN}$  and anode to  $V_{OUT}$ ). The Schottky diode forward voltage should be less than 0.45V.

### Thermal Considerations and High Output Current Applications

The AAT4280 is designed to deliver a continuous output load current. The limiting characteristic for maximum safe operating output load current is package power dissipation. In order to obtain high operating currents, careful device layout and circuit operating conditions need to be taken into account.

The following discussions will assume the load switch is mounted on a printed circuit board utilizing the minimum recommended footprint, as stated in the Layout Considerations section of this datasheet.

At any given ambient temperature ( $T_A$ ), the maximum package power dissipation can be determined by the following equation:

$$P_{D(MAX)} = \frac{[T_{J(MAX)} - T_A]}{\theta_{JA}}$$

Constants for the AAT4280 are maximum junction temperature,  $T_{J(MAX)} = 125^\circ\text{C}$ , and package thermal resistance,  $\theta_{JA} = 120^\circ\text{C}/\text{W}$ . Worst case conditions are calculated at the maximum operating temperature where  $T_A = 85^\circ\text{C}$ . Typical conditions are calculated under normal ambient conditions where  $T_A = 25^\circ\text{C}$ . At  $T_A = 85^\circ\text{C}$ ,  $P_{D(MAX)} = 333\text{mW}$ . At  $T_A = 25^\circ\text{C}$ ,  $P_{D(MAX)} = 833\text{mW}$ .

The maximum continuous output current for the AAT4280 is a function of the package power dissipation and the  $R_{DS}$  of the MOSFET at  $T_{J(MAX)}$ . The maximum  $R_{DS}$  of the MOSFET at  $T_{J(MAX)}$  is calculated by increasing the maximum room temperature  $R_{DS}$  by the  $R_{DS}$  temperature coefficient. The temperature coefficient ( $T_C$ ) is 2800ppm/ $^\circ\text{C}$ . Therefore,

$$\text{MAX } R_{DS125^\circ\text{C}} = R_{DS25^\circ\text{C}} \cdot (1 + T_C \cdot \Delta T)$$

$$\text{MAX } R_{DS125^\circ\text{C}} = 120\text{m}\Omega \cdot (1 + 0.0028 \cdot (125^\circ\text{C} - 25^\circ\text{C})) = 154\text{m}\Omega$$

For maximum current, refer to the following equation:

$$I_{OUT(MAX)} < \frac{P_{D(MAX)}}{R_{DS}}$$

For example, if  $V_{IN} = 5V$ ,  $R_{DS(MAX)} = 154m\Omega$  and  $T_A = 25^\circ C$ ,  $I_{OUT(MAX)} = 2.3A$ . If the output load current were to exceed 2.3A or if the ambient temperature were to increase, the internal die temperature would increase, and the device would be damaged.

Higher peak currents can be obtained with the AAT4280. To accomplish this, the device thermal resistance must be reduced by increasing the heat sink area or by operating the load switch in a duty-cycle manner.

### High Peak Output Current Applications

Some applications require the load switch to operate at a continuous nominal current level with short duration, high-current peaks. The duty cycle for both output current levels must be taken into account. To do so, first calculate the power dissipation at the nominal continuous current level, and then add in the additional power dissipation due to the short duration, high-current peak scaled by the duty factor.

For example, a 4V system using an AAT4280 operates at a continuous 100mA load current level and has short 2A current peaks, as in a GSM application. The current peak occurs for 576 $\mu s$  out of a 4.61ms period.

First, the current duty cycle is calculated:

$$\% \text{ Peak Duty Cycle: } X/100 = 576\mu s/4.61ms$$

$$\% \text{ Peak Duty Cycle} = 12.5\%$$

The load current is 100mA for 87.5% of the 4.61ms period and 2A for 12.5% of the period. Since the Electrical Characteristics do not report  $R_{DS(MAX)}$  for 4V operation, it must be calculated approximately by consulting the chart of  $R_{DS(ON)}$  vs.  $V_{IN}$ . The  $R_{DS}$  reported for 5V can be scaled by the ratio seen in the chart to derive the  $R_{DS}$  for a 4V  $V_{IN}$ :  $120m\Omega \cdot 87m\Omega / 80m\Omega = 130m\Omega$ . De-rated for temperature:  $130m\Omega \times (1 + 0.0028 \cdot (125^\circ C - 25^\circ C)) = 166m\Omega$ . The power dissipation for a 100mA load is calculated as follows:

$$P_{D(MAX)} = I_{OUT}^2 \cdot R_{DS}$$

$$P_{D(100mA)} = (100mA)^2 \cdot 166m\Omega$$

$$P_{D(100mA)} = 1.66mW$$

$$P_{D(87.5\%D/C)} = \%DC \cdot P_{D(100mA)}$$

$$P_{D(87.5\%D/C)} = 0.875 \cdot 1.66mW$$

$$P_{D(87.5\%D/C)} = 1.45mW$$

The power dissipation for 100mA load at 87.5% duty cycle is 1.45mW. Now the power dissipation for the remaining 12.5% of the duty cycle at 2A is calculated:

$$P_{D(MAX)} = I_{OUT}^2 \cdot R_{DS}$$

$$P_{D(2A)} = (2A)^2 \cdot 166m\Omega$$

$$P_{D(2A)} = 664mW$$

$$P_{D(12.5\%D/C)} = \%DC \cdot P_{D(2A)}$$

$$P_{D(12.5\%D/C)} = 0.125 \cdot 664mW$$

$$P_{D(12.5\%D/C)} = 83mW$$

The power dissipation for 2A load at 12.5% duty cycle is 83mW. Finally, the two power figures are summed to determine the total true power dissipation under the varied load.

$$P_{D(total)} = P_{D(100mA)} + P_{D(2A)}$$

$$P_{D(total)} = 1.45mW + 83mW$$

$$P_{D(total)} = 84.5mW$$

The maximum power dissipation for the AAT4280 operating at an ambient temperature of 85 $^\circ C$  is 333mW. The device in this example will have a total power dissipation of 84.5mW. This is well within the thermal limits for safe operation of the device; in fact, at 85 $^\circ C$ , the AAT4280 will handle a 2A pulse for up to 50% duty cycle. At lower ambient temperatures, the duty cycle can be further increased.

### Printed Circuit Board Layout Recommendations

For proper thermal management and to take advantage of the low  $R_{DS(ON)}$  of the AAT4280, a few circuit board layout rules should be followed:  $V_{IN}$  and  $V_{OUT}$  should be routed using wider than normal traces, and GND should be connected to a ground plane. To maximize package thermal dissipation and power handling capacity of the AAT4280 SOT23-6/ SC70JW-8 package, the ground plane area connected to the ground pins should be made as large as possible. For best performance,  $C_{IN}$  and  $C_{OUT}$  should be placed close to the package pins.

### Evaluation Board Layout

The AAT4280 evaluation layout follows the printed circuit board layout recommendations, and can be used for good applications layout. Refer to Figures 1 through 3.

Note: Board layout shown is not to scale.

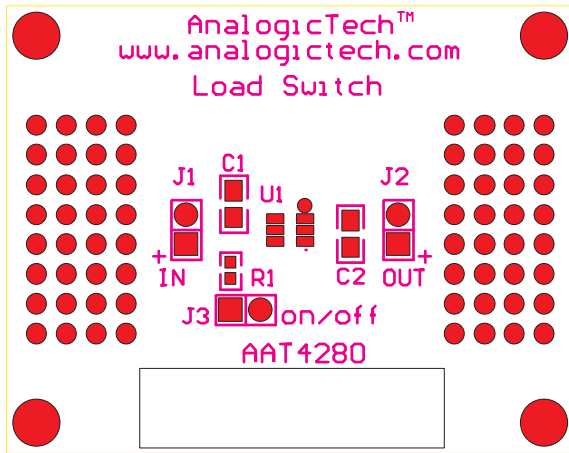

Figure 1: AAT4280 Evaluation Board Top Side Silk Screen Layout / Assembly Drawing.

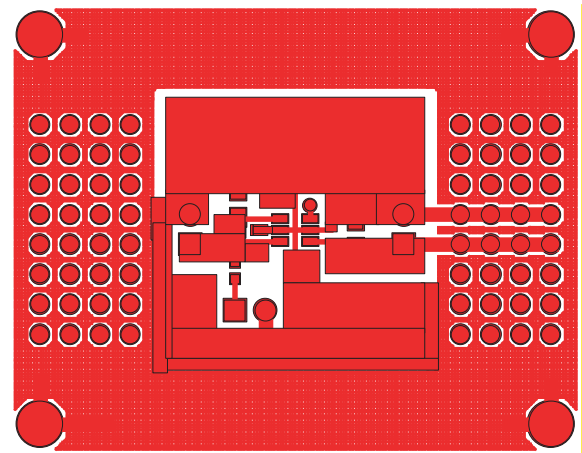

Figure 2: AAT4280 Evaluation Board Component Side Layout.

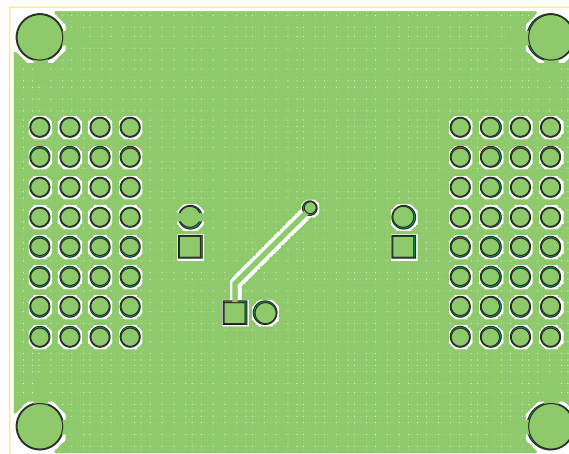

Figure 3: AAT4280 Evaluation Board Solder Side Layout.

## Ordering Information

Device Option	Package	Marking <sup>1</sup>	Part Number (Tape and Reel) <sup>2</sup>
AAT4280-1	SOT23-6	COXYY	<b>AAT4280IGU-1-T1</b>
AAT4280-2	SOT23-6	BZXYY	<b>AAT4280IGU-2-T1</b>
AAT4280-3	SOT23-6	CJXYY	<b>AAT4280IGU-3-T1</b>
AAT4280-1	SC70JW-8	COXYY	<b>AAT4280IJS-1-T1</b>
AAT4280-2	SC70JW-8	BZXYY	<b>AAT4280IJS-2-T1</b>
AAT4280-3	SC70JW-8	CJXYY	<b>AAT4280IJS-3-T1</b>



All AnalogicTech products are offered in Pb-free packaging. The term “Pb-free” means semiconductor products that are in compliance with current RoHS standards, including the requirement that lead not exceed 0.1% by weight in homogeneous materials. For more information, please visit our website at <http://www.analogictech.com/aboutus/quality.php>.

## Package Information

### SOT23-6

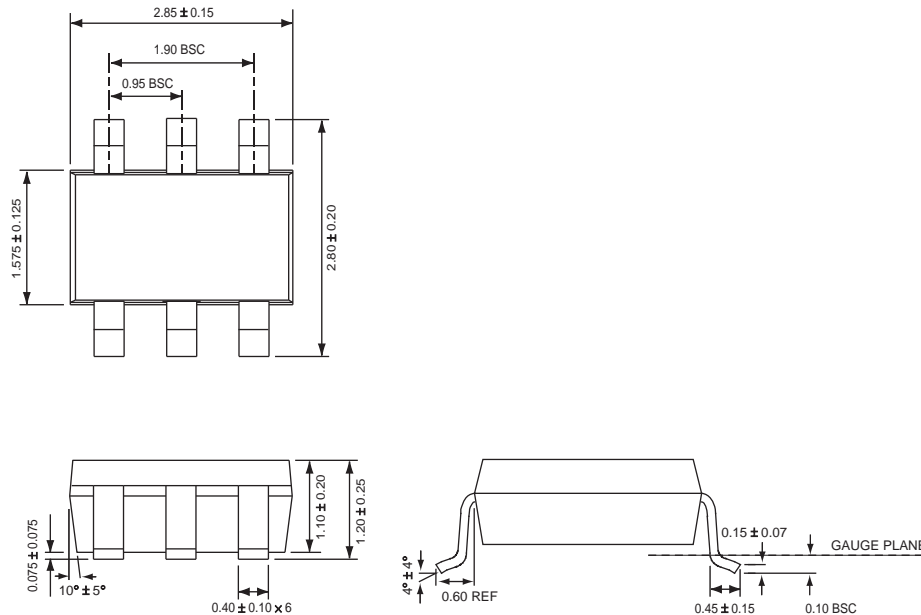

All dimensions in millimeters.

1. XYY = assembly and date code.  
2. Sample stock is generally held on all part numbers listed in **BOLD**.

### SC70JW-8

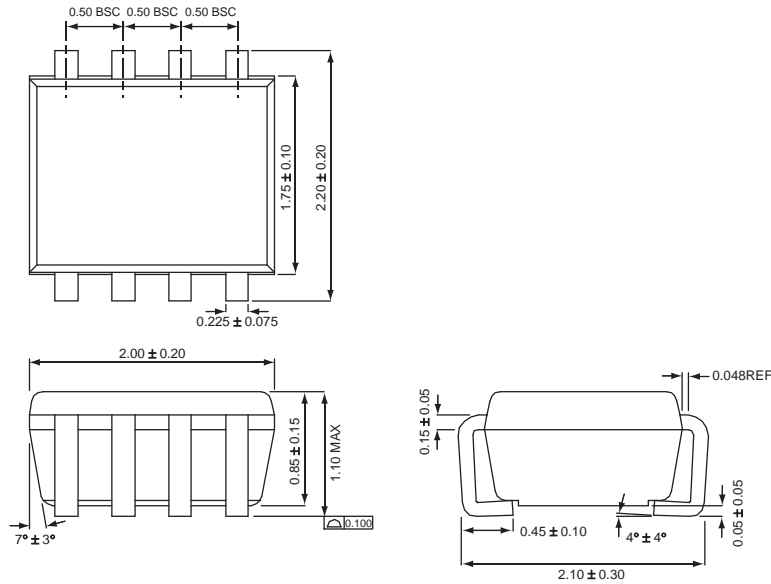

All dimensions in millimeters.

Advanced Analogic Technologies, Inc.  
 3230 Scott Boulevard, Santa Clara, CA 95054  
 Phone (408) 737-4600  
 Fax (408) 737-4611



© Advanced Analogic Technologies, Inc. AnalogicTech cannot assume responsibility for use of any circuitry other than circuitry entirely embodied in an AnalogicTech product. No circuit patent licenses, copyrights, mask work rights, or other intellectual property rights are implied. AnalogicTech reserves the right to make changes to their products or specifications or to discontinue any product or service without notice. Except as provided in AnalogicTech's terms and conditions of sale, AnalogicTech assumes no liability whatsoever, and AnalogicTech disclaims any express or implied warranty relating to the sale and/or use of AnalogicTech products including liability or warranties relating to fitness for a particular purpose, merchantability, or infringement of any patent, copyright or other intellectual property right. In order to minimize risks associated with the customer's applications, adequate design and operating safeguards must be provided by the customer to minimize inherent or procedural hazards. Testing and other quality control techniques are utilized to the extent AnalogicTech deems necessary to support this warranty. Specific testing of all parameters of each device is not necessarily performed. AnalogicTech and the AnalogicTech logo are trademarks of Advanced Analogic Technologies Incorporated. All other brand and product names appearing in this document are registered trademarks or trademarks of their respective holders.